

RR600 Trailer Assembly Manual

- 1.) Unpack all pieces from the tub assembly & crate.



- 2.) Find the bag of hardware and open.



- 3.) Find the main frame, lay on the floor with tabs facing up.



- 4.) Place the walking beams between the tabs on either side, there is not a right or left, either walking beam can be used for both sides and insert pins.



5.) Use 13mm nut and bolt to hold pin to tab, tighten.



6.) Install cotter pin, repeat for the opposite side.

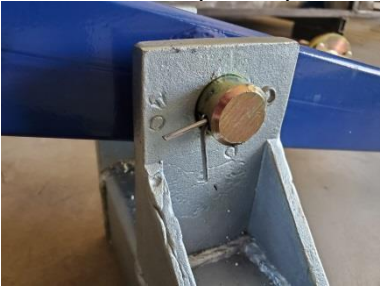

7.) Grease both pins liberally using a grease gun.

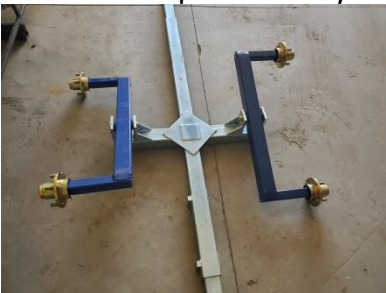

8.) Install all 4 tires, R oin one side L on the other and tighten wheel nuts to 40ft/lbs.



9.) Flip frame section over so that the frame is higher than the walking beams and slide frame rail in.



10.) Install 4 bolts with nuts into main frame.



11.) Frame rail should extend approximately 40" passed main frame, tighten all 4 bolts and then all 4 nuts.



12.) Find rear bunk frame, it has the brackets for the tub pivot pins on it, slide onto rear of frame tube, when both tubes are flush tighten bolts and nuts.



13.) Find front bunk frame and slide onto the frame.



- 14.) The tub is approximately 79" long so the front edge of the bunk to clear the front of the tub.



- 15.) Slide safety cage section onto front of frame, it should sit about 80 1/2" from rear hinges, install 2 large bolts and nuts.



- 16.) Install outriggers and retaining handles.



- 17.) Find hitch swivel and install to front of frame tube, tighten bolts, grease swivel with grease gun.



18.) Install Tub.



19.) Install pins and safety clips.



20.) Check position of safety cage and tighten bolts.



21.) Check position of front bunk mount and tighten bolts.



22.)

23.) Find crane and winch mount, 2 long bolts and nuts, hold upper section on lining up holes, install 2 bolts and tighten nuts.



24.) Install Winch.



25.) Install winch Handle.



26.) Remove bolt and reverse the position of the swivel lock pin.



27.) Install Swivel plate, tighten the nut so that it locks but plate must move freely, install spring around lock lever and through the hole in the plate.



28.) Remove bolt holding winch cable roller, run winch cable through and re-install roller, tighten nut & bolt.



29.) Make sure all cable rollers are tightened into locknuts



30.) Mount crane arm to frame hinge mount.



31.) Remove chain locking pins from swivel plate.



32.) Lift crane arm to desired position, run chains into locks on the swivel plate, install lock pins,



33.) Tighten bolt holding chains to boom.



34.) Tighten bolt hold boom swivel into the locknut but not tight, swivel must be able to move,



35.) Run winch cable out through boom and outer pulley.



36.) Connect winch line hook to loop inside of tub.

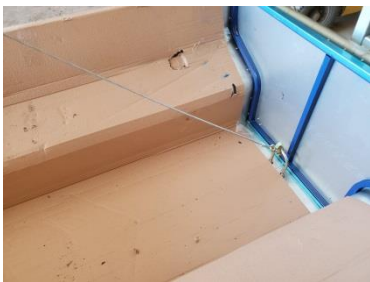

37.) Install 4 Orange bunk arms and 4 upper log holders.



Test winch position, when lifting the tub winch line must not touch tub end door.



Loosen 4 main frame bolts and pull inner tube forward or backward to make frame length shorter or longer.



ASSEMBLY DRAWING

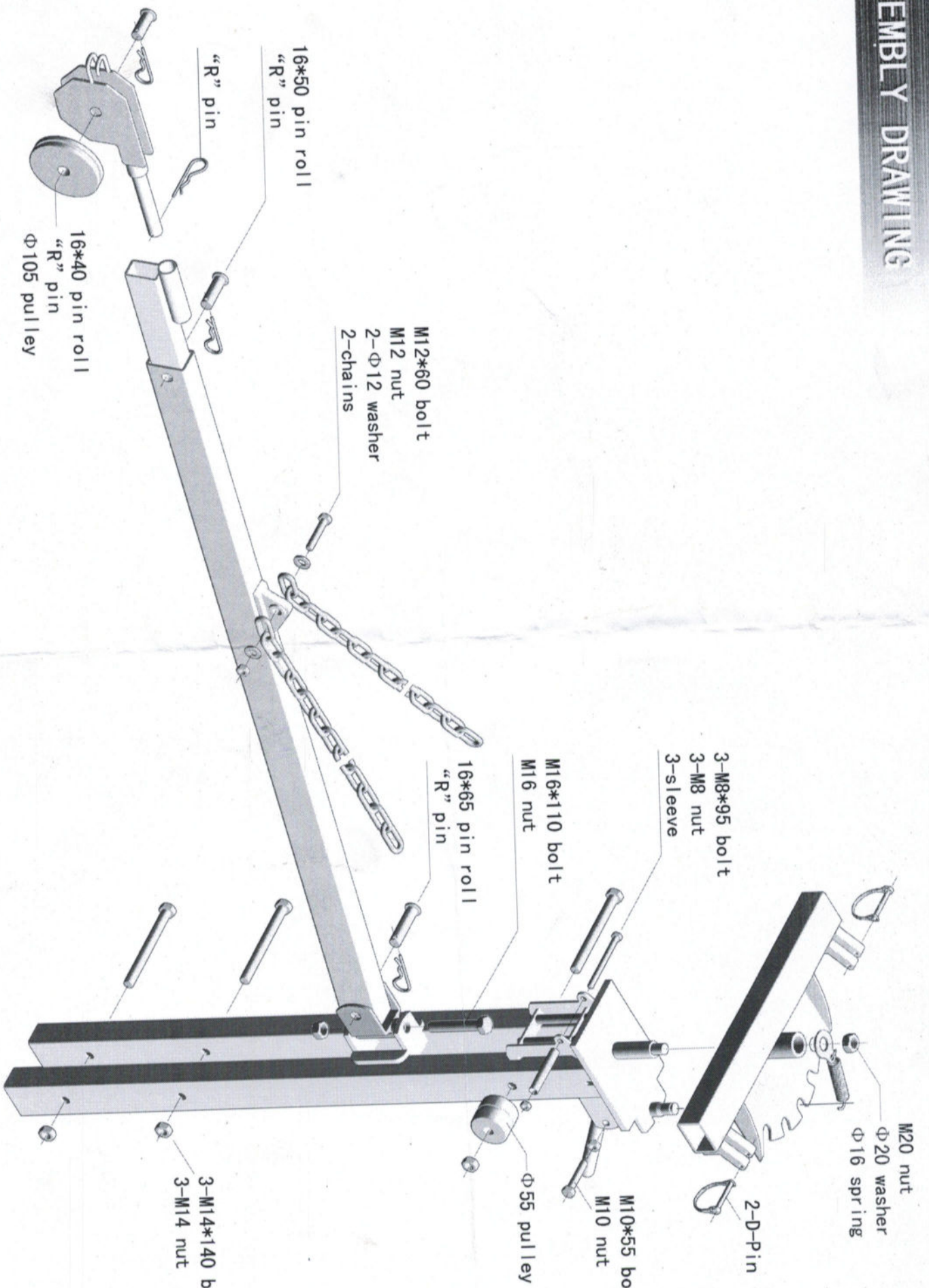

ASSEMBLY DRAWING

- 2-M10*90 bolt
- 2-M10 nut
- 2-Φ10 washer
- 2-Φ10 spring washer
- 2-Φ16 bolt sleeve

⑤

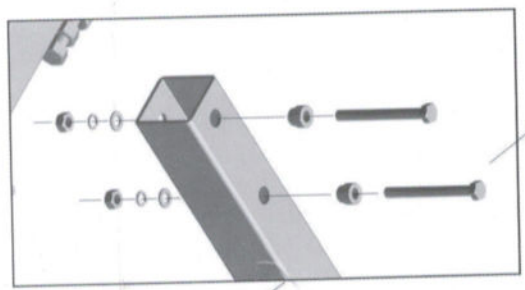

- 2-M8*30 bolt
- 2-M8 nut
- 2-Φ8 washer
- 2-Φ8 spring washer
- 2-Φ5*50 dowel pin

①

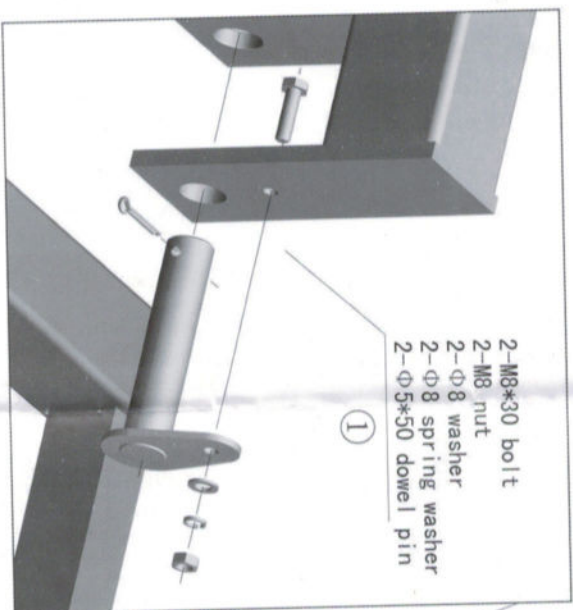

Please pay attention to the installation direction of the tyres and the tyre brackets.

- 2-M10*70 bolt
- 2-M10 nut
- 2-Φ10 washer
- 2-Φ10 spring washer

⑤

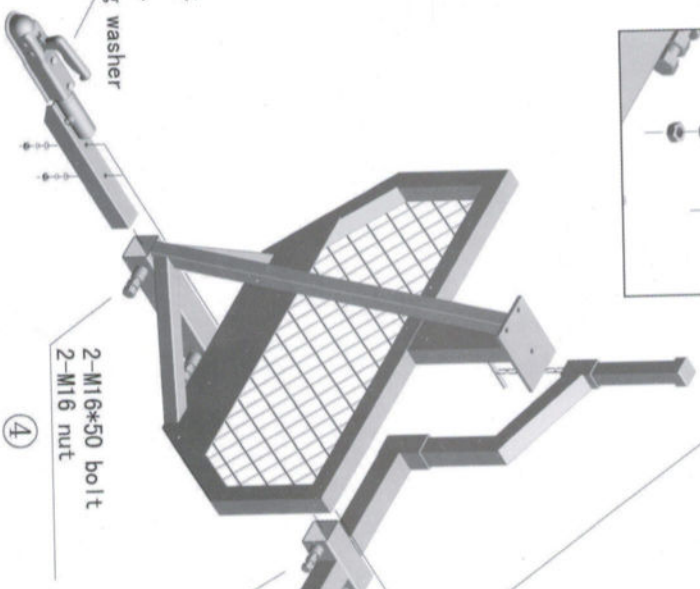

- 2-M16*50 bolt
- 2-M16 nut

④

- 2-M12*50 bolt
- 2-M12 nut

③



- 4-M12*50 bolt
- 4-M12 nut

⑥

- 16-M12 wheel hub nut

②

- 2-M12*50 bolt
- 2-M12 nut

⑦